

Features

- Resolution : 25 mm
- Min. detectable object size : 30 Ø
- Output : PNP Antivalent
- High reliability
- Short circuit & reverse polarity protected output

PLCP-580-A2-V1

Technical data

Beams	24
Sensing height	580 mm
Resolution	25 mm
Setting distance	0.5 ~ 5.0 m
Detectable size	Opaque target minimum 30 Ø
Operating voltage	24 +/- 20% VDC ; +/- 20% P-P MAX
Current consumption	180 mA/ 24 beams
Output	PNP Antivalent
Output current	100 mA max.
Output status	All light channel, Light ON
Protection	Short circuit & reverse polarity protected output
Residual voltage	0.8 VDC max.
Leakage current	0.8 mA max.
Indicator	Yellow: power; Green: clear condition; Red: block condition
Response time	10 ms
Reset time	Output reset time < 200 ms
Ambient light limit	Lamp < 10,000 lux; sunlight < 20,000 lux
Protection class	IP65
Connection	M12 x 1.0 connector
Housing material	Housing: aluminium; End cap: PBT; Front cover: acrylic
Ambient parameters	0 °C ~ 50 °C; 25% ~ 85% RH
Vibration resistance	10 ~ 55 Hz / 1.5 mm, 2 hours X.Y.Z direction
EMC standard	ESD: 8 KV air charge (level 3) / EN-61000-4-2 RF interference: 10V / M/ ENV50140 Burst test: 2KV / EN61000-4-4

Dimensions

PLCP-580-A2-V1

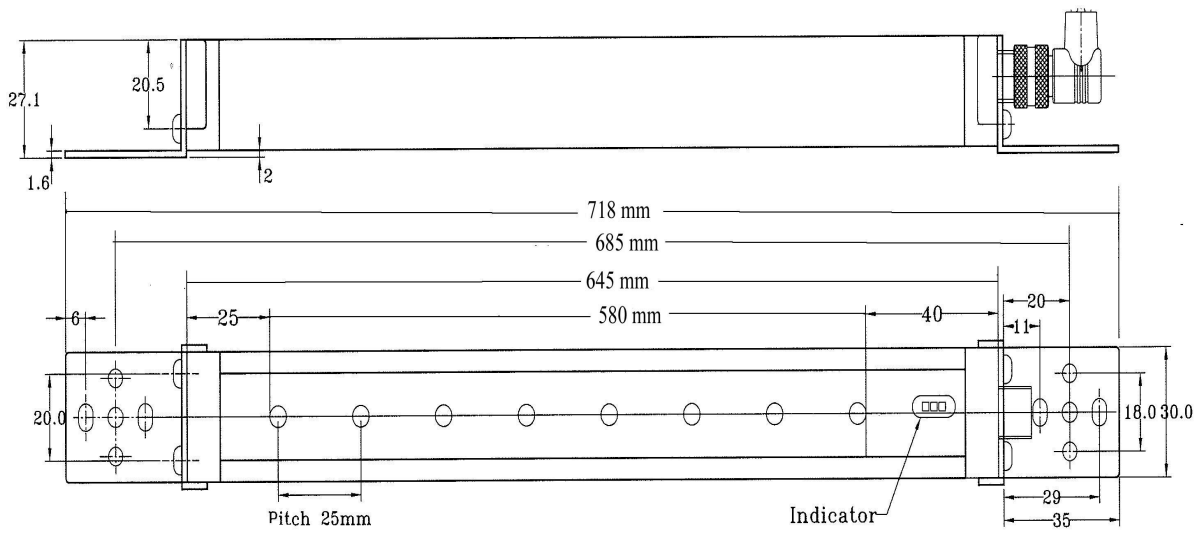

Electrical Connection

Emitter

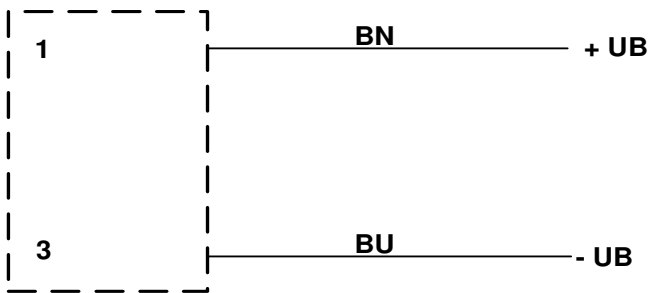

Receiver

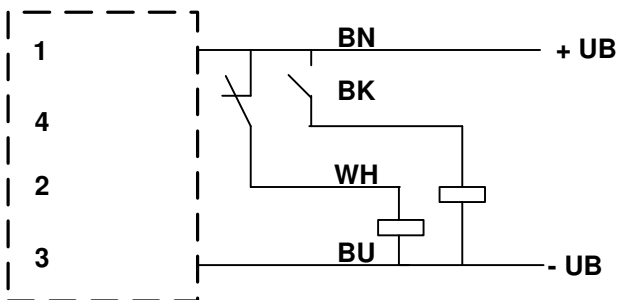

THE SPECIFICATION AND APPLICATION OF THE LIGHT CURTAIN IS NOT GOVERNED UNDER SAFETY REGULATIONS AND CERTIFICATIONS.